



STEGANOGRAPHY

Hiding in plain sight



What is Stegano?

- Conceal a message within another
- Imperceptible, unless you know where to look
- Intuitively used since Antiquity, formalized in modern times



vs Crypto

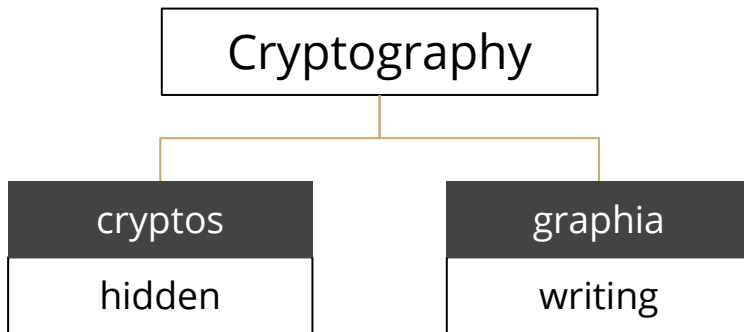

- Writing in a secret code
- Alter message, without hiding
- Obfuscates data
- Defends

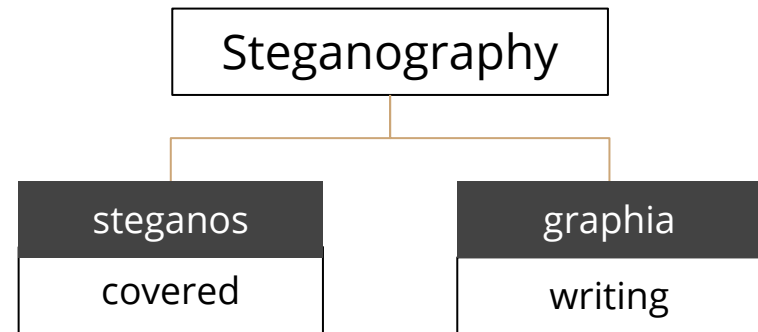

- Change message meaning
- Doesn't attract interest
- Obfuscates the communication
- Deters

vs Watermarking



Watermarking

- Unremovable message
- one:many communication



Steganography

- Undetectable message
- one:one communication



Since everyone can read, encoding text
in neutral sentences is doubtfully effective





Since everyone can read, encoding text
in neutral sentences is doubtfully effective



S e c r e t
i n s i d e

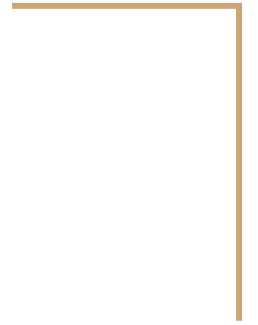

Secret
inside

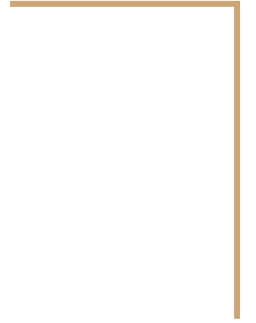
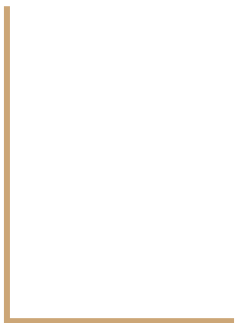

Historical Example

- Documented by Herodotus in 440BC:
 1. Shave slave head
 2. Mark Persian attack plans on scalp
 3. Wait for hair to regrow
 4. Send through enemy territory
 5. Greek receiver shaves head
- Drawbacks:
 - Waiting time for hair to grow
 - Limited message size



Recent Historical Examples

- 300 BC: Invisible ink, visible only when heated
- WW I: Message knitted into a piece of yarn worn by a courier
- WW II: Tiny “micro-dots” printed over newspapers
- 1966: Prisoner of war blinking “TORTURE” in morse code



Modern Examples

- Large cover (relative to secret) means easier to hide
- Media files are ideal
 - Text, audio, images, video
- Unicode characters that look like standard ones
- Set every 100th pixel of an image to an ASCII code
- Ignored sections of the file
- Delays in network packets sent

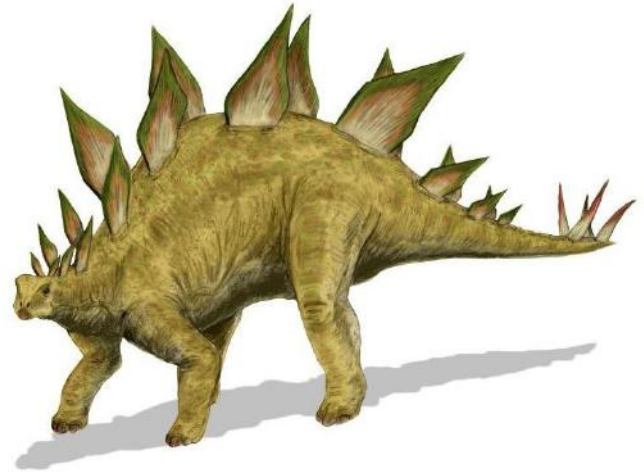

Steganosaurus: a covered lizard

Methods Categories

- Pure (no key)
- Secret key
- Public key

Stego-medium = cover + secret + key

Properties

- Imperceptibility
 - A measure of the amount of distortion to the cover
 - Stego-medium indistinguishable from stego-cover
- Embedding capacity
 - Amount of data that can be hidden in a cover, compared to the size of the cover
- Undetectability
 - Maintain statistical properties of the cover file
- Robustness
 - Retain the hidden data even after the cover has been subjected to various changes
 - Should be difficult to destroy the secret information without destroying the cover
- Tamper resistance
 - Resistance to the attempts of altering the hidden data

Image Stegano

- Most popular type of Stegano
- Large embedding capacity
- Methods focus on noise manipulation
 - Hard to detect by the human eye
 - Circumvent statistical methods masquarading as randomness

Text Stegano

- Most difficult type of stegano
- Low embedding capacity
- Dependent on the used language
- Requirements:
 - Letter frequencies resembling a natural language
 - Most words should be found in a good dictionary
 - Syntactically correct sentence

Text Methods

- Format Based

- Uses:
 - Word shift coding: shift horizontal location of word in text
 - Line shift
 - Unicode characters
- Vulnerable to OCR or retyping



- Semantic Based

- Based on linguistic transformations
 - Word synonyms
 - Word deletion
- Can alter sentence meaning

The idea is a **powerful** one → The idea is a **potent** one
This computer is **powerful** → This computer is **potent**

Word	Synonym
big	large
find	observe
familiar	popular
chilly	cool

Mimic Functions

start → **adj noun tense verb**

adj → the **size** | a **size**

size → tiny | small | large | big

noun → saw | ladder | truth | boy

tense → is | was

verb → waiting | standing

cover: The large ladder was waiting

hidden:

Mimic Functions

start → **adj noun tense verb**

adj → **the size** | a **size**

– first production

size → tiny | small | large | big

noun → saw | ladder | truth | boy

tense → is | was

verb → waiting | standing

cover: **The** large ladder was waiting

hidden: **∅**

Mimic Functions

start → **adj noun tense verb**

adj → the **size** | a **size**

size → tiny | small | **large** | big

– third production

noun → saw | ladder | truth | boy

tense → is | was

verb → waiting | standing

cover: The **large** ladder was waiting

hidden: 0**10**

Mimic Functions

start → **adj noun tense verb**

adj → the **size** | a **size**

size → tiny | small | large | big

noun → saw | **ladder** | truth | boy

– second production

tense → is | was

verb → waiting | standing

cover: The large **ladder** was waiting

hidden: 01001

Mimic Functions

start → **adj noun tense verb**

adj → the **size** | a **size**

size → tiny | small | large | big

noun → saw | ladder | truth | boy

tense → is | **was**

verb → waiting | standing

– second production

cover: The large ladder **was** waiting

hidden: 010011

Mimic Functions

start → **adj noun tense verb**

adj → the **size** | a **size**

size → tiny | small | large | big

noun → saw | ladder | truth | boy

tense → is | was

verb → **waiting** | standing

– first production

cover: The large ladder was waiting

hidden: 0100111

Implemented Techniques

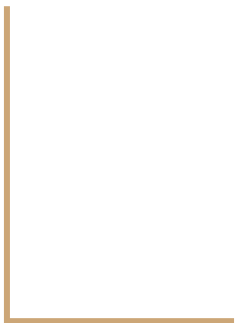
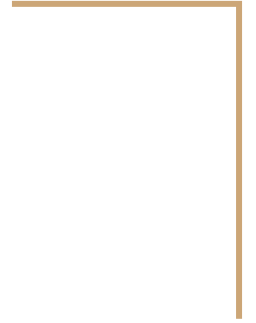

Block Scheme

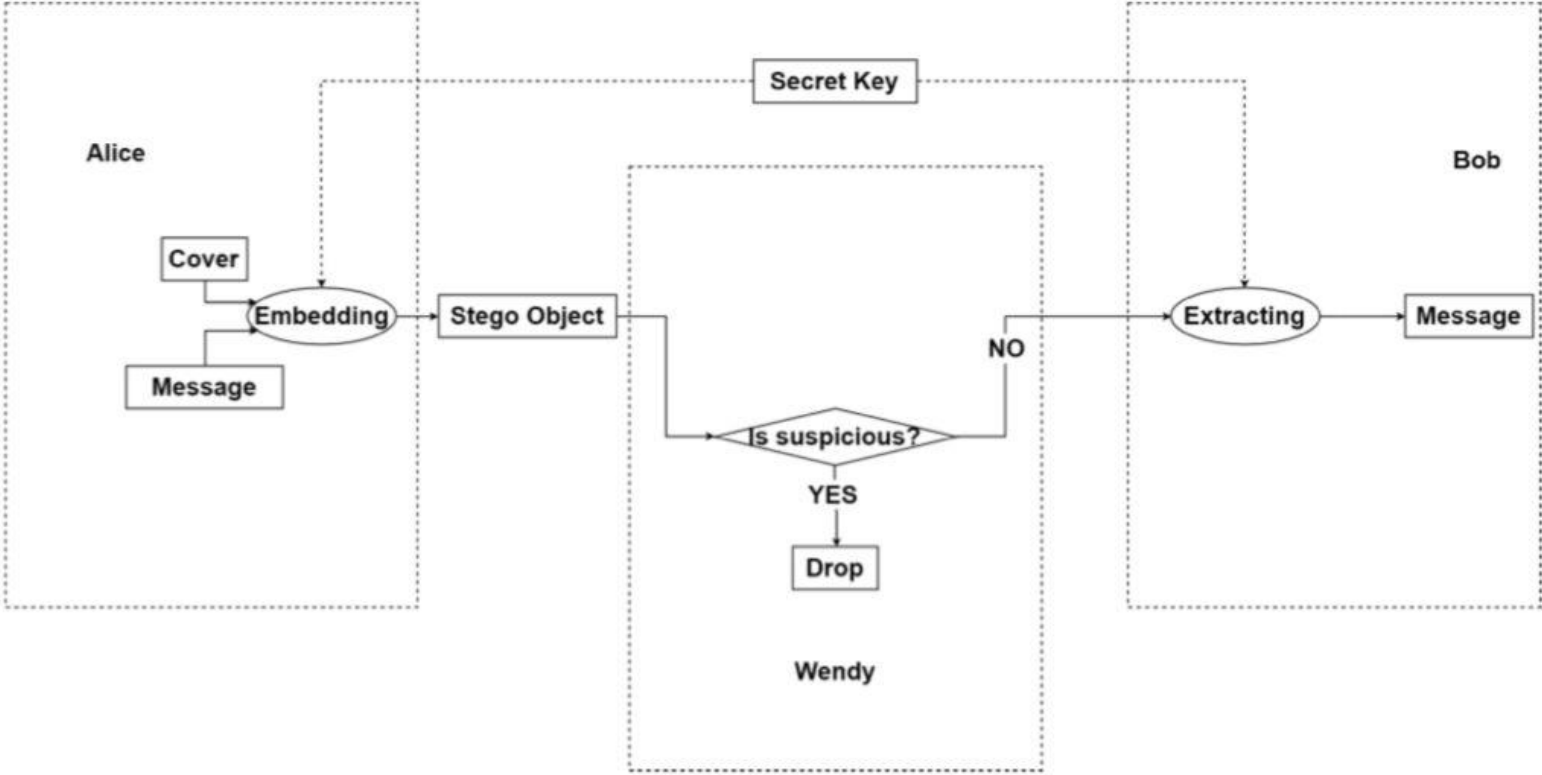

Text Demo

Zero-width unicode characters:

Imperceptibly hiding a text in a regular message

Unicode Steganography with Zero-Width Characters

Cover Text: (length: 29)

This is an innocuous message.

Hidden Text: (length: 15)

Secret message!

Steganography Text: (length: 0)

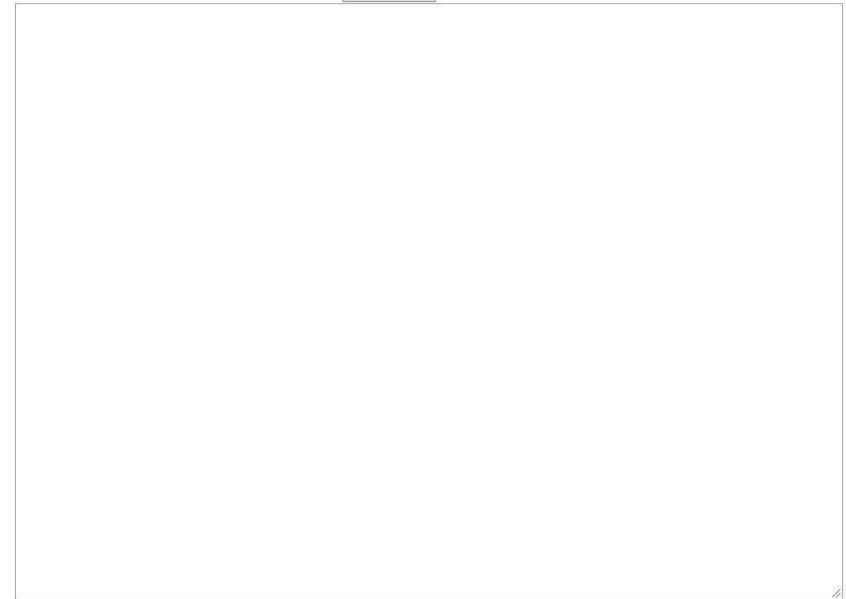

Unicode Steganography with Zero-Width Characters

Cover Text: (length: 29)

This is an innocuous message.

Hidden Text: (length: 0)

« Decode

Steganography Text: (length: 149)

This is an innocuous message.

Unicode Steganography with Zero-Width Characters

Cover Text: (length: 29)

This is an innocuous message.

Hidden Text: (length: 15)

Secret message!

Steganography Text: (length: 149)

This is an innocuous message.

Remarks

Pros:

- High embedding capacity
- High imperceptibility
- Easy to implement

Cons:

- Very vulnerable to programs that remove blank spaces in text
- Vulnerable to retyping
- Increases the length of the cover image

Image Demo

LSB insertion:

Hiding an image in the Least
Significant Bits of another

LSB Insertion

- Objective: changes to carrier (injecting payload) to be visually (and statistically) negligible
- Images are a good carrier
 - Analog signal digitization
 - Lossy compression error
- Bitmap (.bmp) uses 8 bits for each RGB channel
 - Slight changes undetectable by human eye (256 levels)
- Best in noisy areas
 - Allows payload to blend in with natural color variation
 - Wide, solid areas magnify any added noise

Human Eye Test



1111 1111

Pure blue



?

How many bits differ?

Human Eye Test

1111 1111

1100 0000

Human Eye Test

1111 1111

?

Same color?

Human Eye Test

1111 1111

1110 0000

Human Eye Test

1111 1111

?

What about now?

Human Eye Test

1111 1111

1111 1110



Cover



Cover



encode

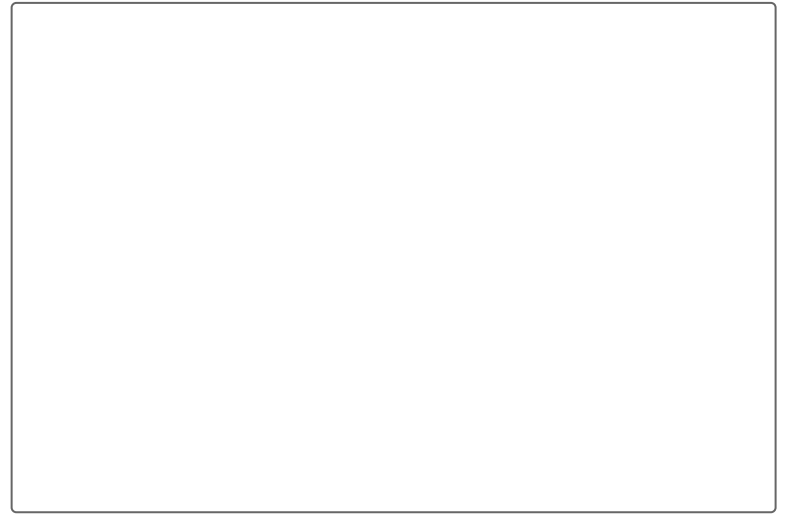

Secret



Message



Message

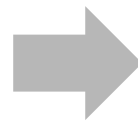

decode



Recovered



Cover



encode



Secret



Message



decode



Recovered

Robustness

- Very vulnerable to transformations
 - Geometrical
 - Blurring
- Compression destroys it
 - LSB insertion exploits what lossy compression algorithms (JPEG) rely on:
low human eye sensitivity to added noise
- Useless for watermarking
 - Doesn't withstand destruction attempts
 - Doesn't translate well to print
- Better suited for stegano
 - Robustness not so important
 - High data rate

Solution

- Hinder malicious attempts at reading secret
- Randomize the placement of bits
 - Using a cryptographical random function (scattering)
- Can't decode without seed

Steganalysis

- Statistical analysis to detect hidden messages:
- Split image into blocks
- Compute average value of LSBs in each block
- Random data should have around 0.5

Closing Words

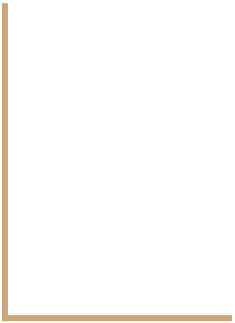
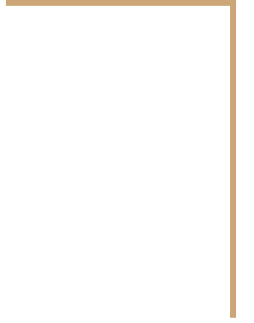

Recent Advances

- ML-based attacks
 - Embedding location finder for image steganography
 - Employ transfer learning for CNNs
- ML-based detection
 - Continuation of statistical steganalysis methods
 - Alleviates the need for feature engineering
- Domain at the intersection of:
 - Information Theory
 - Data compression
 - Cryptography

Applications

- *Domain still young*
- Military
- Anti-counterfeit
- Illegal trades
- Internet banking
- Online elections
- Intelligence agencies
- Medical imaging

Thank you!

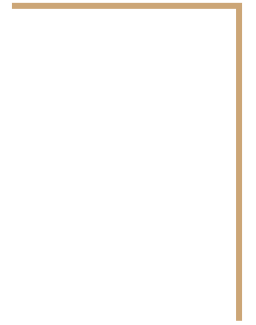
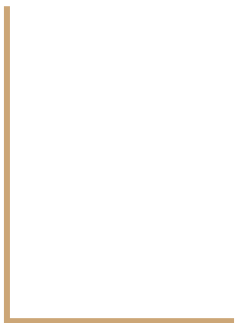

References

1. C.P. Sumathi et al, **A Study of Various Steganographic Techniques Used for Information Hiding**, International Journal of Computer Science & Engineering Survey, 2013
2. A. Odeh & K. Elleithy, **Steganography in Text by Merge ZWC and Space Character**, 2013
3. R. Kumar et al, **An efficient text steganography scheme using Unicode Space Characters**, 2015
4. D. Salomon, **Data Hiding in Text**. In: **Data Privacy and Security**, Springer, 2003
5. H.A. Atee et al, **Extreme learning machine based optimal embedding location finder for image steganography**, 2017
6. D. Dumitrescu et al, **Steganography techniques**, 2017
7. S.M. Thampi, **Information Hiding Techniques: A Tutorial Review**, LBS College of Engineering, 2008
8. K. Thangadurai & G.S. Devi, **An analysis of LSB based image steganography techniques**, International Conference on Computer Communication and Informatics, 2014